



# Carry Series

## HDD/SSD

### Duplicator and Sanitizer

#### User Manual

v A.01

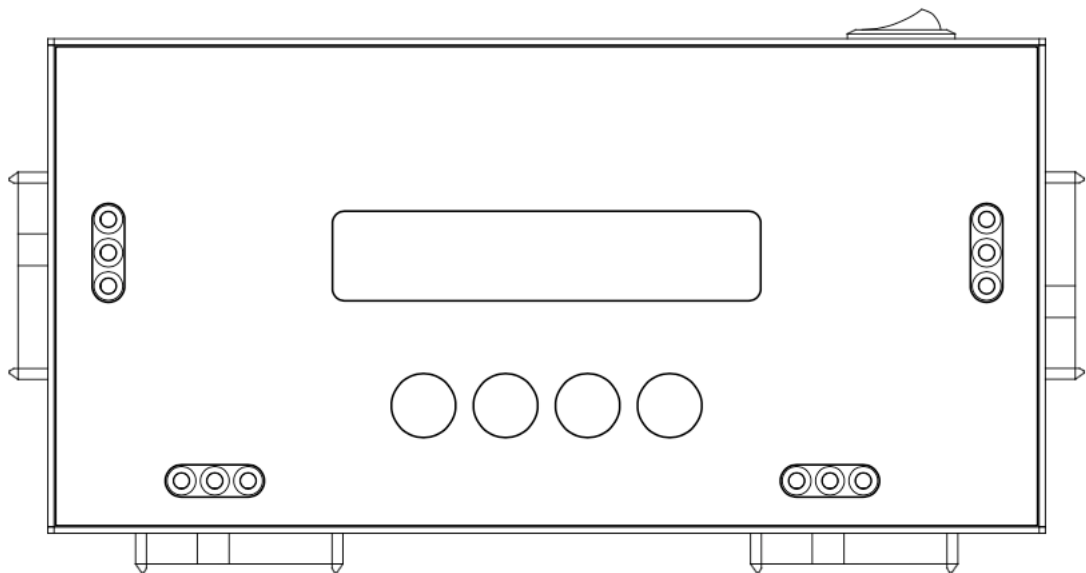

# Index Table

Product Disclaimer .....	2
Warranty .....	2
Piracy Statement .....	2
Before You Start .....	3
Notice Symbols.....	3
Product Overview.....	4
1. Copy .....	8
2. Compare .....	9
3. Copy+Compare .....	9
4. Erase .....	9
5. Utility .....	11
6. Setup.....	13

## **Product Disclaimer**

U-Reach is not accountable for any incidental or consequential damages, including, but not limited to property harm, loss of time or data from use of any U-Reach product, or any other damages attributable to product malfunction or failure of including without limitation, those attributed to reliance of the materials provided, costs of product replacement, loss of use, data or profits, delays or business interruptions, any principle of legal responsibility arising from or in reference to the use, overall performance, delays in servicing, or lack of ability to render service of any U-Reach product. U-Reach makes every effort to ensure proper function of all products. However, the customer is responsible for verifying that the output of U-Reach product meets the customer's quality requirement. The customer further acknowledges that improper use of U-Reach products, software program, and/or hardware issues can cause loss of data, defective formatting, or unreliable data loading. U-Reach will make efforts to resolve or repair any issues recognized by customer either within the warranty period or on a time and materials basis. Specifications and features are subject to change without notice or obligation.

## **Warranty**

U-Reach provides a basic, one-year parts and labor warranty for all its products, excluding cables, adapters, and other consumable items. An extended warranty may be purchased. Telephone and email support are available for the life of the product as defined by U-Reach.

All warranties are specific to a market region and will be defined per the market region in which the product was purchased.

## **Piracy Statement**

U-Reach accepts no responsibility for copyright infringement or misuse of any U-Reach equipment. Copying any form of data (audio, video, or software) without the permission of the copyright holder is illegal. It is the sole responsibility of the user to ensure that the legal copyrights of the copyright owners are respected.

# Before You Start

## Important Notice

- Carefully read the entire manual before operating.
- Make sure the source device is correct and functioning.
- Equal capacity of source and target is recommended for guaranteed data consistency.
- Using the Copy+Compare function provides the most flawless duplication.
- Damage incurred due to non-compliance with U-Reach operating instructions will void the warranty.
- Store the equipment safely when not in use and keep out of the reach of children.
- Please turn off duplicator before replacing sockets.
- Never turn off the power while the firmware updates.
- Use only approved, stable power sources.
- The power supply has overload protection. When it is overloaded and shutdown, please unplug the power cord for 2 minutes for discharging.
- Use product only in a clean, dry, dust-free, and ventilated area. Liquids or foreign debris can severely damage your duplicator.
- It is typical for the machine to heat up during operation.
- While in use, do not move the duplicator or remove SSDs.
- Static electricity may cause duplication error. Please pay attention to the duplicator's environment while operating equipment. Purchasing electricity elimination equipment helps avoid shock.
- Devices will operate at high-temperatures during selected tasks.
- Wear protective gloves to prevent burns when handling devices.
- Ensure machine and operator are properly grounded to prevent ESD.

## Notice Symbols

Special items, procedures, or notes to be observed prior to use:

### Note

Refers to related duplicator operations, special details, tips, or suggestions for operational effectiveness.

### Caution

Refers to procedures that need to be adhered to or precautions.

# Product Overview

- Hardware

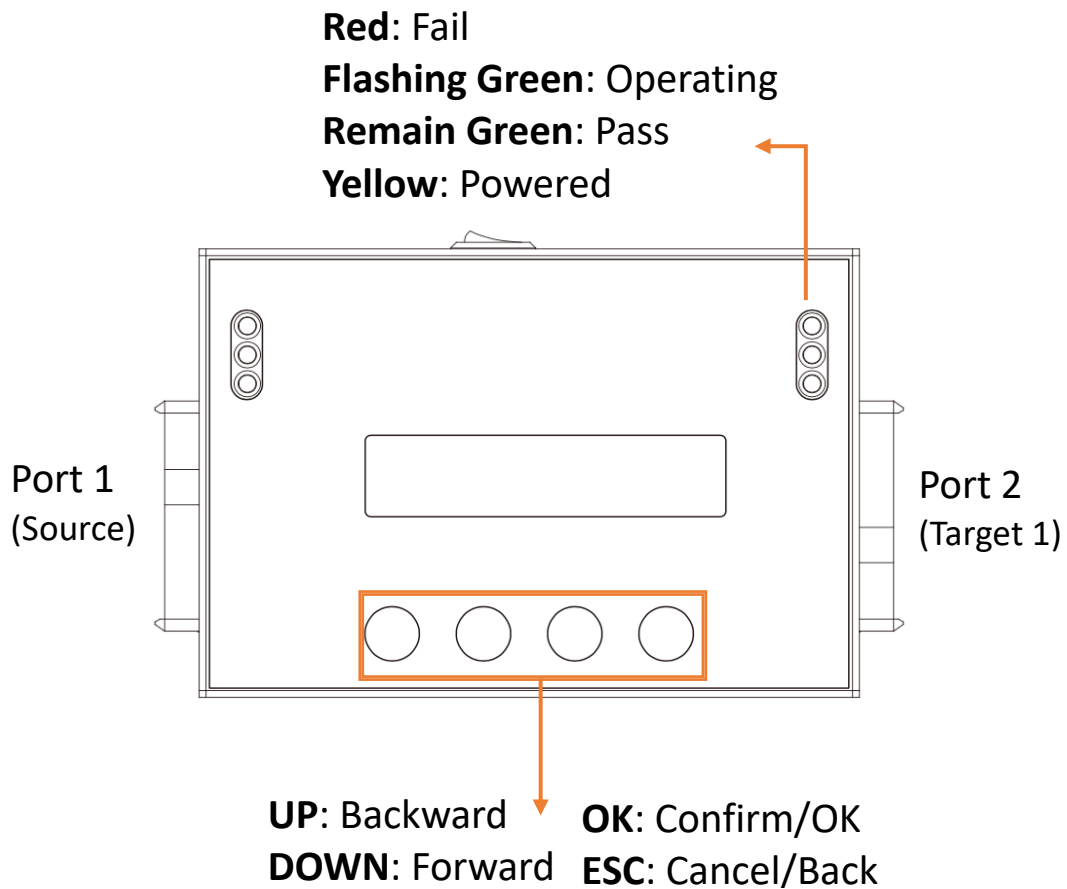

- LCD configuration

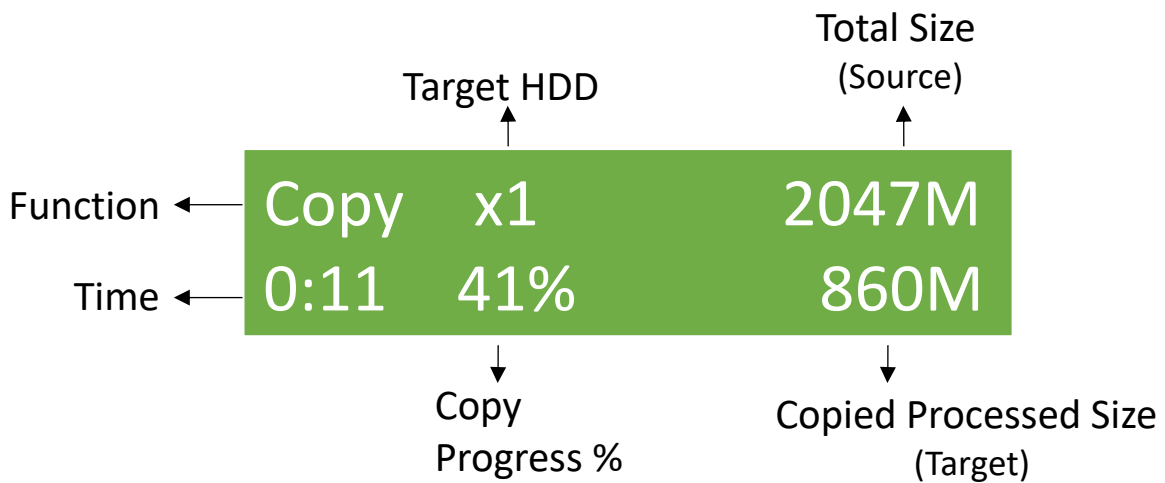

# Function Table

Function	Description	
<b>1. Copy</b>	To copy source HDD to multiple target HDDs. Refer to function [6.1 Copy Area] for 4 different copy modes selection.	
<b>2. Compare</b>	To compare data bit for bit between source and target HDDs.	
<b>3. Copy +Compare</b>	It makes copy first and then compare target HDD with source HDD to ensure data correctness.	
<b>4. Erase</b>	<b>4.1 Quick Erase</b> To erase HDD's index table only, it takes short time to execute this function.	
	<b>4.2 Full Erase</b> To erase the whole HDD content.	
	<b>4.3 DoD Erase</b> To erase HDDs three times complying with USA Department of Defense (DoD) standard.	
	<b>4.4 DoD EraseComp</b> To erase HDDs three times complying with USA Department of Defense (DoD) standard and bit by bit to check if data is completely erased.	
	<b>4.5 7-Pass Erase</b> Erases device(s) 7 times complying with DoD 5220.22-M(ECE) Standards.	
	<b>4.6 Secure Erase</b> The international authorized high standard Secure Erase function. It can erase the area which is not loadable.	
	<b>4.7 Enhanced Secure Erase</b> Erases devices that support this feature.	
<b>5. Utility</b>	<b>5.1 Show Disk Info.</b> Displays basic information such as device model, name, capacity, etc.	
	<b>5.2 Update System</b>	<b>5.2.1 Update BIOS</b> To update the system firmware via the HDD.
		<b>5.2.2 Create Update HDD</b> To format the HDD with a 2GB FAT partition to quickly save the new firmware in the HDD.
	<b>5.3 System Info.</b> This function will show information of the duplicator system, including	

	controller model, number, and software version.		
<b>6. Setup</b>	<b>6.1 Copy Area</b>	<b>6.1.1 System and Files</b> To copy source HDD's data area only.	
		<b>6.1.2 ALL Partitions</b> To copy source HDD's all partitions.	
		<b>6.1.3 Whole HDD</b> To copy the whole source HDD.	
		<b>6.1.4 Percentage (%)</b> To copy percentage range of source HDD.	
	<b>6.2 Copy GPT Backup Area</b> Enable this function to copy the end GPT format.		
	<b>6.3 Skip Errors</b> Skips bad sectors of source HDD during Copy/Compare/Erase.		
	<b>6.4 Language</b> English / Japanese		
	<b>6.5 Delete Disk Signature After Copy</b>	<b>No</b>	
		<b>Yes</b> Do not copy the disk signature onto target devices.	
	<b>6.6 Advanced Setup</b>	<b>6.6.1 Unknown Format</b>	<b>6.6.1.1 Copy Unknown</b> Copy unknown area when the device cannot identify the format.
			<b>6.6.1.2 Skip Unknown</b> Skip copy unknown area when the device cannot identify the format.
		<b>6.6.2 Erase Master</b> (Setup to erase source HDD or not.)	<b>6.6.2.1 Enable</b> Enable erase source HDD.
			<b>6.6.2.2 Disable</b> Disable erase source HDD.
		<b>6.6.3 Erase Pattern</b>	<b>6.6.3.1 ONE Byte</b> A random character to be written into every byte.
<b>6.6.3.2 Big Random Data</b> A set of random character to be written into a set of area.			

	<p><b>6.6.4 Wait HDD Time</b> Auto start time after plugging HDD from 0~30 seconds.</p>
	<p><b>6.6.5 Mark After Erase</b> Creates watermark on the device(s) after erase job is completed.</p>
	<p><b>6.6.6 Transfer Rate</b> Select the proper transfer rate from UDMA2~UDMA7. UDMA7 is the fastest.</p>
	<p><b>6.6.7 Stop Motor Time</b> Auto running time after stopping motor from 1~20 seconds.</p>
	<p><b>6.7 Restore Default</b> Back to original manufacturer setting.</p>



# Functions

## 1. Copy

### Step 1: Prepare source and target devices.

#### Note

Recommendation: Target device(s)' capacity must be equal to or larger than the source device capacity.

### Step 2: Connect source and target devices.

### Step 3: Proceed to copy.

Scroll to select "1. Copy", then press "OK" to start the duplication process.

#### Note

The number of working/connected targets will be displayed on LCD. Press "OK" to start.

The information below states what is displayed on the LCD during duplication.

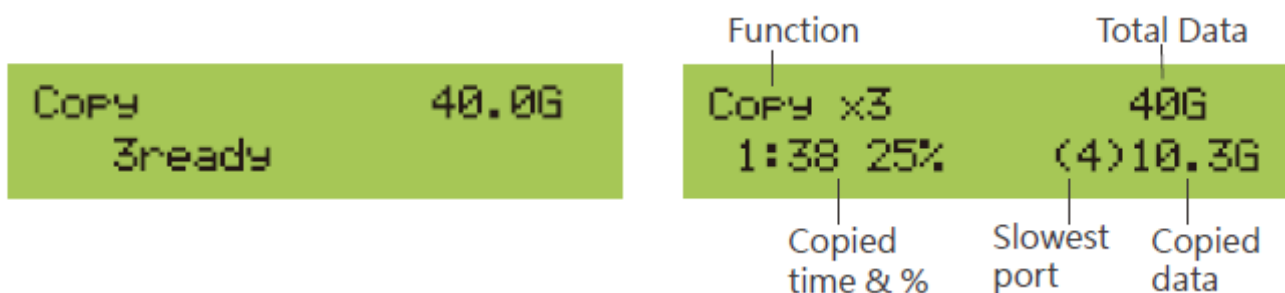

#### Note

- Press "▲▼" together for 5 seconds to stop operation on the slowest device.
- Press "ESC" for 5 seconds to stop all the copy jobs.

#### Caution

It is recommended to reboot the machine after manually stopping the copy.

### Step 4: Copy Completed!

The quantity of passed or failed target device(s), the copied duration, and CRC64 will be displayed on the LCD after duplication completes.

```
Pass:3 Fail:0 8:00  
CRC:7073923CEBDF7B58
```

#### Note

CRC64: During duplication, each port will simultaneously record written data and compare CRC64 between source and targets. The result will be conveyed with a green light (pass) or a red light (fail).

## 2. Compare

Proceed to verify device(s).

Scroll to select "2. Compare", then press "OK" to start the verification process.

### Note

The number of working/connected targets will be displayed on the LCD. Press "OK" to start.

## 3. Copy+Compare

Sequentially automates from Function 1, Copy to Function 2, Compare.

Scroll to select "3. Copy+Compare", then press "OK" to start the automated duplication and verification process.

### Caution

User is responsible for verification of targets' quality. Testing a few completed targets in a mass production environment for quality control is recommended.

## 4. Erase

There are 7 submenu modes.

### Caution

Please back up all important data before using this function.

### Step 1: Connect device(s) for sanitizing.

### Note

Source Port is disabled for erasing. Go to 6.8.2 to enable source port erasing.

### Step 2: Enter function "4. Erase"

Scroll to select "4. Erase", then press "OK" to view the 7 erase modes.

### Step 3: Select an Erase Function.

Here are a couple tips to see port details during erase:

- Press "▲" or "▼" to view real-time status of each port.
- Press "OK" to view the details of each port.

### Step 4: Erase Completed

Here are a few tips to perform or stop an Erase job.

- Press “Asynchronous Erase Button” to start a new Erase job.
- Press “Asynchronous Erase Button” for 5 seconds to stop a single port.
- Press “ESC” for 5 seconds to stop all the erase jobs.

#### Caution

User is responsible for verification of targets’ quality. Testing a few completed targets in a mass production environment for quality control is recommended.

### 4.1 Quick Erase

This function will erase the index table from the connected device(s).

Scroll to select "4.1. Quick Erase", then press "OK" to start the erasing process.

### 4.2 Full Erase

This function will erase all data per NIST 800-88 Standards on the connected device(s).

Scroll to select "4.2 Full Erase", then press "OK" to start the erasing process.

### 4.3 DoD Erase

This function will erase all data per DoD 5220.22-M Standards on the connected device(s).

Scroll to select "4.3 DoD Erase", then press "OK" to start the erasing process.

### 4.4 DoD Erase Comp

This function will erase all data per DoD 5220.22-M Standards, then compare erasure of the connected device(s).

Scroll to select "4.4 DoD EraseComp", then press "OK" to start the erasing and verifying process.

### 4.5 7-Pass Erase

This function will erase device(s) 7 times complying with DoD 5220.22-M(ECE) Standards.

Scroll to select "4.5 7-Pass Erase", then press "OK" to start the erasing process.

### 4.6 Secure Erase

This function erases the non-loadable areas complying with NIST 800-88 Standards.

Scroll to select "4.6 Secure Erase ", then press "OK" to start the erasing process.

**Caution**

If Secure Erase process is interrupted, the device will be locked. Please execute again and wait until it finishes.

### 4.7 Enhanced Secure Erase

This function erases devices that supports this feature.

Scroll to select "4.7 Enhanced Secure Erase", then press "OK" to start the erasing process.

## 5. Utility

This menu contains submenus related to device information, system information and updates.

Scroll to "5. Utility", then press "OK" to view the submenus.

### 5.1 Show Disk Info

This function will display basic information such as device model, name, capacity, etc...

Scroll to select "5.1 Disk Info", then press "OK" to view the connected device(s). Then scroll through to view connected device(s) by port number order.

### 5.2 Update System

This function is to execute firmware updating of system.

You can follow the following steps to update the system firmware.

#### Step 1: Create an Update HDD

Place a SDD/HDD to the duplicator. Select function "5.2.2 Create Update HDD".

[Update System]  
2. Create Update HDD

#### Step 2: Format BIOS HDD

Click "OK" to format the BIOS hard disk. One FAT, 2GB partition will be formatted in HDD. That would reduce searching time, and speed up firmware update.

**Caution** The data saved in this HDD will be erased.

### Step 3: Download Firmware

Connect the BIOS HDD to PC. Download the latest firmware from PC and save it to HDD. Unzip BIOS, and save it to the root directory.

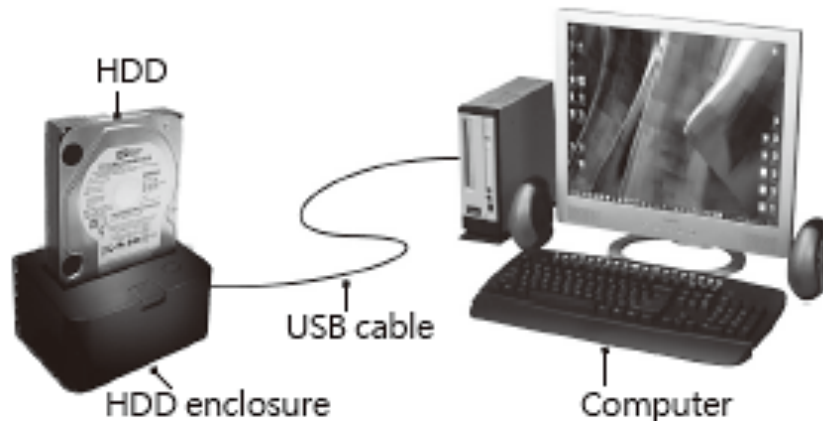

### Step 4: Enter "Update BIOS"

Place the BIOS HDD into source port. Enter function "5.2.1 Update BIOS". Update will take about a minute to complete.

[Update System]  
1. Update BIOS

**Caution** Please do not disrupt during BIOS update, otherwise it would cause irretrievable error on duplicator. We are not held responsible for any damages.

### 5.3 System Info.

This function will display basic information such as controller, model number, software version, etc.

Scroll to select "5.3 System Info", then press "OK" to view all information.

## 6. Setup

### 6.1 Copy Area

There are 4 submenu modes.

Scroll to select "6.1 Copy Area", then press "OK." Then scroll through to select one of the four copy methods.

- Selecting the Proper Copy Modes

Example: There are two defined partitions in a 500GB device. The charts below illustrate what portion would be duplicated.

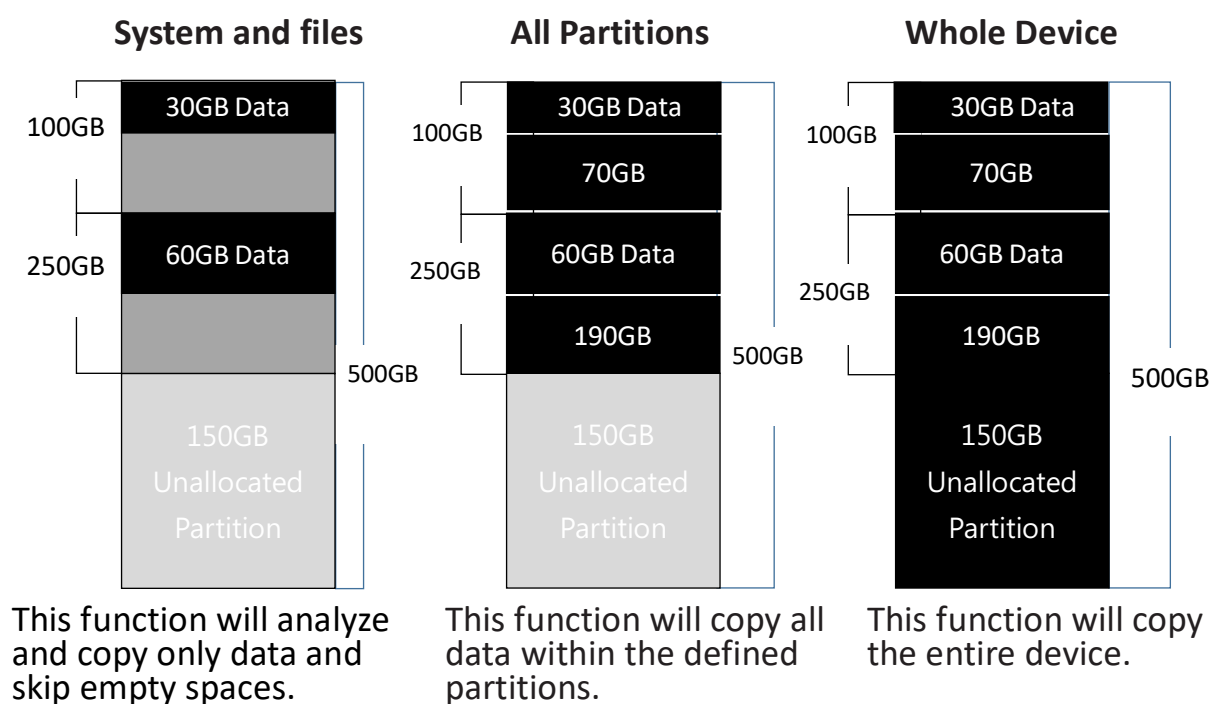

- Copy and Compare Preparations

Please consider the following settings before proceeding with copy or compare:

- 6.1 Copy Area
- 6.2 Copy GPT Backup Area
- 6.3 Skip Errors
- 6.6.1 Unknown Format

Using appropriate copy modes can greatly reduce operation time and increase efficiency. There are four copy modes with different copy methods.

### 6.1.1 System and Files

Copies data and skips empty space. Only supports standardized formats.

Scroll to select "System and Files", then press "OK" to save the copy method.

Allows user to copy source device's System and Files, instead of the entire device. The system will analyze the source device and identify the data area to copy. If the source device's data is within the target device's capacity, the copy will be processed. FAT16/32/64, NTFS, EXT2/EXT3/EXT4, and HFS/HFS+/HFSX are supported in this copy mode.



```
[Copy Area]
System and Files
```

### 6.1.2 All Partitions

Copies all partitions and data, unallocated partitions not included.

Scroll to select "All Partitions", then press "OK" to save the copy method.

The target device's capacity must be equal to or larger than the source device's capacity.

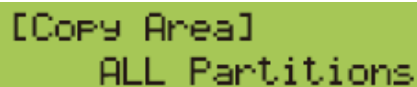

```
[Copy Area]
ALL Partitions
```

### 6.1.3 Whole HDD

Copies all source data bit by bit.

Scroll to select "Whole Device", then press "OK" to save the copy method.

Copies the whole source device, irrespective of content, format, partition or empty space. This mode does not analyze the data.



```
[Copy Area]
Whole HDD
```

### 6.1.4 Percentage (%)

Select percentage of source capacity to copy.

Scroll to select "Percentage", set the upper and lower %, then press "OK" to save the copy method.

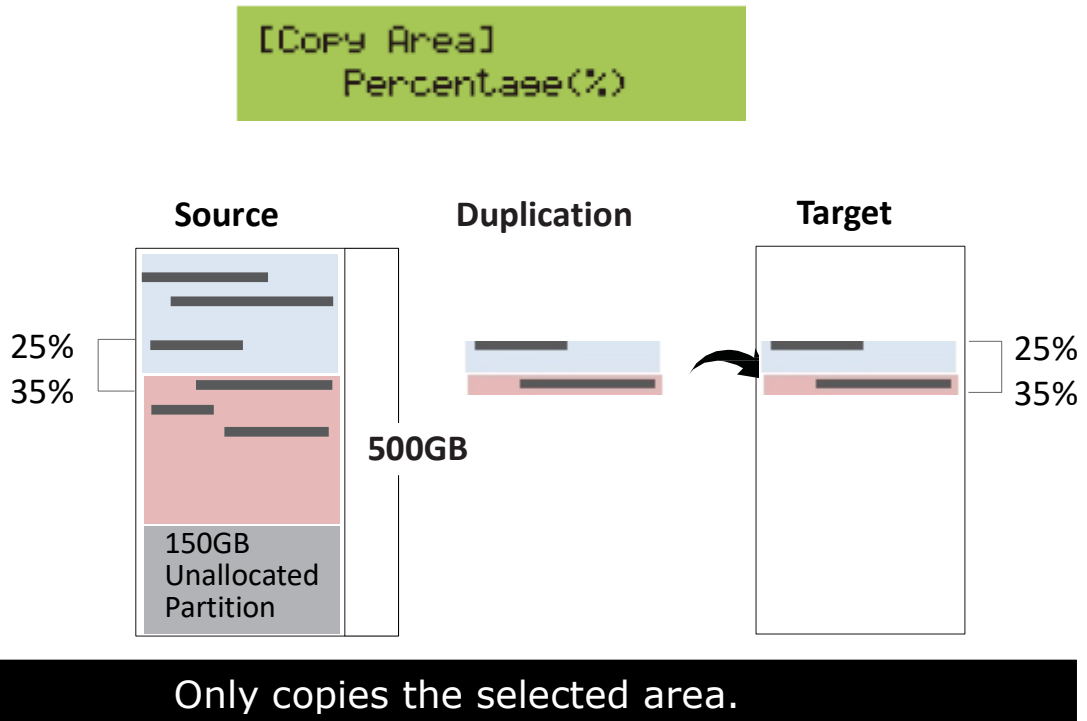

### 6.2 Copy GPT Backup Area

Enabling this function allows the duplicator to copy from big capacity device to small capacity device(s).

**Caution** The partition size of the source HDD must be smaller than target capacity.

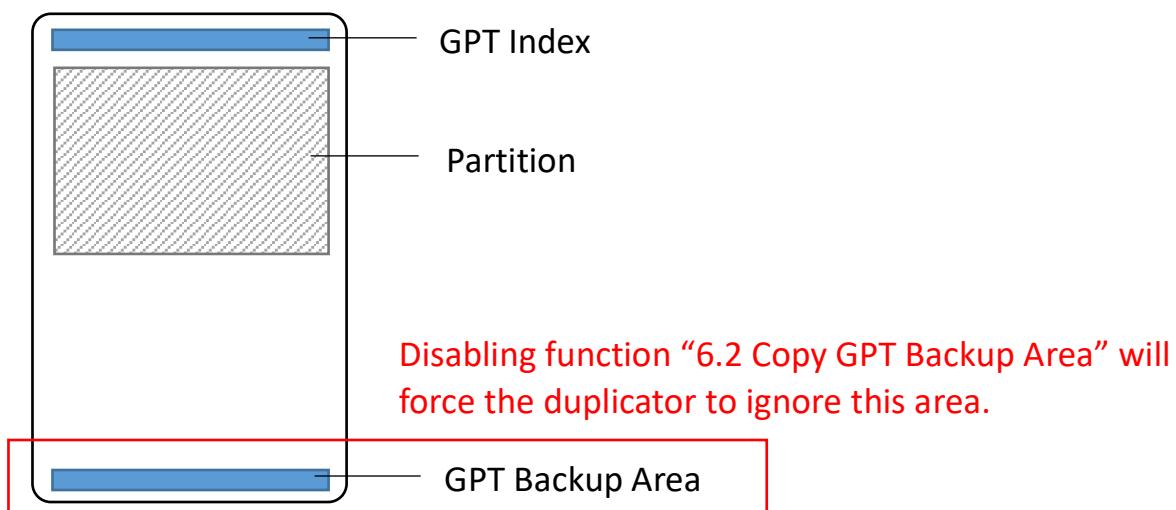



**Caution**

If function is disabled, the target HDD will reconstruct the GPT Backup Area by Windows system. It may require the HDD to restart in order to work.

### 6.3 Skip Errors

Skips bad sectors during Copy/ Compare/ Erase.

Scroll to select "6.3 Skip Errors", then press "OK" to scroll through the available values for skipping bad sectors. If the device data is critical and needs to be a full clone, it is recommended to set "Skip Error" at "0." Bad sectors can be set as unlimited or at a value from 0 to 65,535.

**Caution**

The "Copy+Compare" function is advised for enhanced copy accuracy.

### 6.4 Language

Select English or Japanese.

Scroll to select "6.4 Language", then press "OK." Then scroll through to select the desired language.

### 6.5 Delete Disk Signature After Copy

Set at "Yes" means do not copy the disk signature part.

This function is for Windows only. Windows will only recognize one device if you connect two or more with the same disk signature.

**Caution**

"Compare" function will always Fail if "5.8.8 Delete Disk Signature After Copy" is set at "Yes."

### 6.6 Advanced Setup

#### 6.6.1 Unknown Format

This function only works with "6.1 Copy Area >> System and Files."

Scroll to select "6.6.1 Unknown Format", then press "OK".

Unknown format includes all forms of modified and proprietary data and partitions.

#### ① Copy Unknown

Copy unknown format(s).

Scroll to select "6.6.1 Unknown Format >> Copy Unknown", then press "OK" to save this setting.

**② Skip Unknown**

Skip unknown format(s).

Scroll to select "6.6.1 Unknown Format >> Skip Unknown", then press "OK" to save this setting.

### **6.6.2 Erase Master**

This function allows user to enable or disable the source port for sanitization. Scroll to select "6.6.2 Erase Master", then press "OK." Then scroll through to select one of two settings.

**① Disabled**

Devices connected to source port cannot be erased.

Scroll to select "6.6.2 Erase Master >> Disabled", then press "OK" to save this setting.

**② Enabled**

Devices connected to source port can be erased.

Scroll to select "6.6.2 Erase Master >> Enabled", then press "OK" to save this setting.

### **6.6.3 Erase Pattern**

Scroll to select "6.6.3 Erase Pattern", then press "OK". Then scroll through to select one of two settings.

**① One Byte**

Random character written per byte.

Scroll to select "6.6.3 Erase Pattern >> One Byte", then press "OK" to save this setting.

**② Big Random Data**

Random character written in a set of area.

Scroll to select "6.6.3 Erase Pattern >> Big Random Data", then press "OK" to save this setting.

#### **6.6.4 Wait HDD Time**

Sets device power up buffer time prior to copy, erase, etc...

Scroll to select "6.6.4 Wait HDD Time", then press "OK" to set buffer time from 3 to 30 seconds. The default is 15 seconds.

#### **6.6.5 Mark After Erase**

Creates watermark on the device(s) after erase job is completed. This watermark will show when executing "5.1 Show Disk Info." and can be printed out when connecting to a thermal printer.

#### **6.6.6 Transfer Rate**

Allows user to select the transfer rate.

Scroll to select "6.6.6 Transfer Rate", then press "OK". Select the desired transfer mode from UDMA2 to 7. The default is UDMA7.

#### **6.6.7 Stop Motor Time**

Sets device power down buffer time when tasks are completed.

Scroll to select "6.6.7 Stop Motor Time", then press "OK" to set buffer time from 1 to 20 seconds. The default is 5 seconds.

#### **6.7 Restore Default**

Restores all settings back to manufacturer defaults.

Scroll to select "6.7 Restore Defaults", then press "OK" to restore settings back to manufacturer defaults.

***\*Specifications subject to change without notice.***